

Pumpenträger für E-Motor
L202 / Flansch D200 / Bgr. 2

Art.Nr.: HZBXXX801000

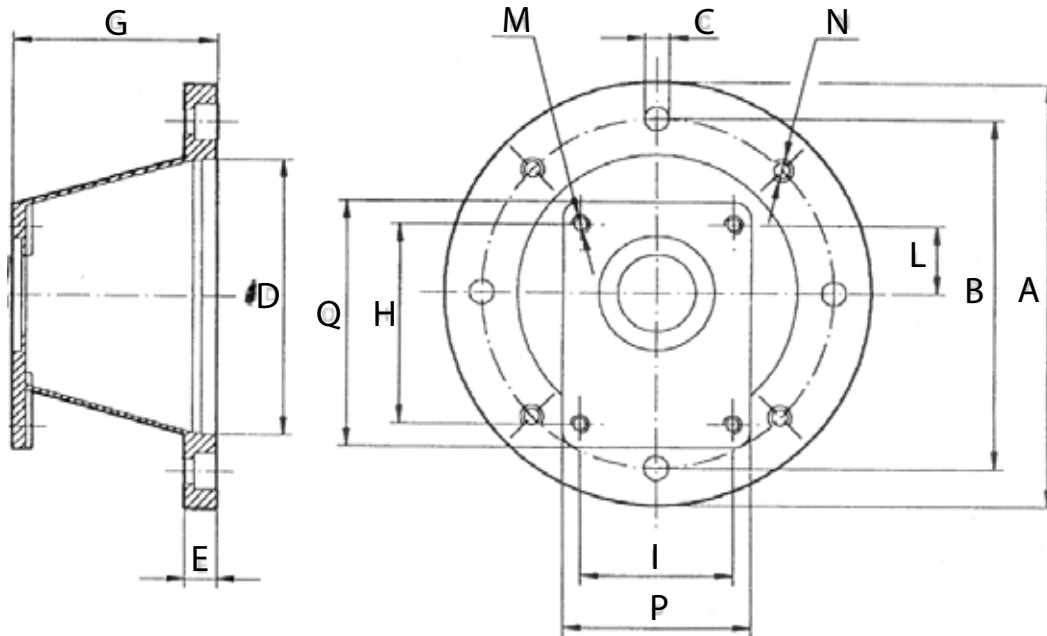

Artikelnummer	Typ	Flansch	Ø A (mm)	Ø B (mm)	Ø C (mm)	Ø D (mm)	E (mm)	G (mm)	H (mm)	I (mm)	L (mm)	Ø M (mm)	Ø N (mm)	O (mm)	P (mm)
HZBXXX800014	L 161	E1/Bgr. 1	160	130	9	110	15	67	72,0	52,4	26,5	M 6	M 8	90	69
HZBXXX800015	L 201	E1/Bgr. 1	200	165	11	130	18	87	72,0	52,4	26,5	M 6	M 10	90	69
HZBXXX800016	L 251	E1/Bgr. 1	250	215	14	180	22	109	72,0	52,4	26,5	M 6	M 12	90	69
HZBXXX801000	L 202	E2/Bgr. 2	200	165	11	130	18	95	96,2	71,5	32,2	M 8	M 10	118	86
HZBXXX800017	L 252	E2/Bgr. 2	250	215	14	180	22	109	96,2	71,5	32,2	M 8	M 12	118	86
HZBXXX800018	L 302	E2/Bgr. 2	300	265	14	230	24	130	96,2	71,5	32,2	M 8	M 12	118	86
HZBXXX800062	L 352	E2/Bgr. 2	350	300	18	250	25	178	95,0	72,0	40,0	M 6	M 16	-	-
HZBXXX800019	L303	E3/Bgr. 3	300	265	14	230	24	147	128,0	98,5	42,0	M 10	M 12	170	120
HZBXXX800020	L 353	E3/Bgr. 3	350	300	18	250	32	179	128,0	98,5	42,0	M 10	M 16	170	120

Bgr. = Pumpengruppe

*Irtümer, technische Änderungen vorbehalten.